

TANK BAG

Accessory Name	Parts Number	Application Model	Issue Date	Publication No.	FRT
TANK BAG	08L71-MKJ-D00	CB650RA/CBR650RA	2020.09	MII	0.1 H
TANK BAG ATTACHMENT	08L72-MKJ-D00				

Introduction

ALL INFORMATION, ILLUSTRATIONS, DIRECTIONS AND SPECIFICATIONS INCLUDED IN THIS PUBLICATION ARE BASED ON THE LATEST PRODUCT INFORMATION AVAILABLE AT THE TIME OF APPROVAL FOR PRINTING. Honda Motor Co., Ltd. RESERVES THE RIGHT TO MAKE CHANGES AT ANY TIME WITHOUT NOTICE AND WITHOUT INCURRING ANY OBLIGATION WHATSOEVER. NO PART OF THIS PUBLICATION MAY BE REPRODUCED WITHOUT WRITTEN PERMISSION. THIS MANUAL IS WRITTEN FOR PERSONS WHO HAVE ACQUIRED BASIC KNOWLEDGE OF MAINTENANCE ON Honda MOTORCYCLES, MOTOR SCOOTERS OR ATVS.

Honda Dealer:







Please give a copy of these instructions to your customer.

Customer:

Because it requires specialized knowledge and special tools and equipment, it is recommended to install it at a dealer with qualified automobile maintenance.

How To Read These Symbols

Your safety, and the safety of others, is very important. To help you make informed decisions we have provided safety messages and other information throughout this manual.

-  **DANGER** You WILL be KILLED or SERIOUSLY HURT if you don't follow instructions.
-  **WARNING** You CAN be KILLED or SERIOUSLY HURT if you don't follow instructions.
-  **CAUTION** You CAN be HURT if you don't follow instructions.
-  **NOTICE** The purpose of this message is to help prevent damage to your vehicle, other property, or the environment.
-  **NOTE** Things you want to know, things that are useful to know.
-  Follow the instructions of the Service Manual.
-  Follow the other symbol instructions of the "Installation Instructions BASIC".

Instruction Other Symbols

The symbols used throughout this instructions show specific service procedures.

Refer to "Installation Instructions BASIC" for description of each symbol.

INFORMATION

⚠ CAUTION

- To prevent burns, allow the engine, exhaust system, radiator, etc., to cool before installing the accessory.

NOTE:

- Heat the bonding surfaces with a hair dryer if the ambient air temperature is below 70°F (21°C).
- The adhesive reaches full strength in 72 hours. Wait at least 24 hours before riding your motorcycle.
- Take care not to damage the painted surfaces of the motorcycle.
- Before installation, remove all dust, sand, etc. from fuel tank and tank bag, as otherwise the fuel tank may be damaged.
- Save all removed parts unless otherwise indicated.
- Although the illustration is of CB650RA, use the same procedures for other models.

PARTS LIST

When the instruction manual and installation instructions are included in this kit, be sure to give them to the customer.

<TANK BAG>

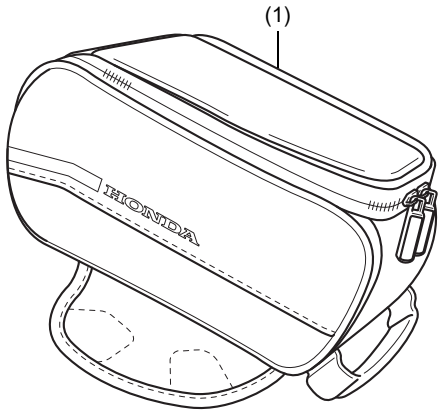
Component	No.	Parts Name	Qty	Parts No.
	(1)	Tank bag	1	-

<TANK BAG ATTACHMENT>

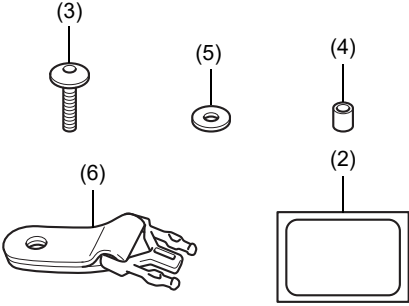
Component	No.	Parts Name	Qty	Parts No.
	(2)	Protective film	2	-
	(3)	6 x 20 mm screw	2	-
	(4)	Collar	2	-
	(5)	Washer	2	90439-MB0-000
	(6)	Tank bag strap	2	-

MAXIMUM LOADING CAPACITY

- The weight of the cargo must not exceed the following maximum loading capacity:

Maximum Loading Capacity	
Tank bag	1.0 kg (2.2 lb)

TORQUE INFORMATION

Refer to the Service Manual for the torque values of the removed parts. (Refer to )

INSTALLATION

1. Refer to the Service Manual for the motorcycle, remove the motorcycle parts as shown. (📖)

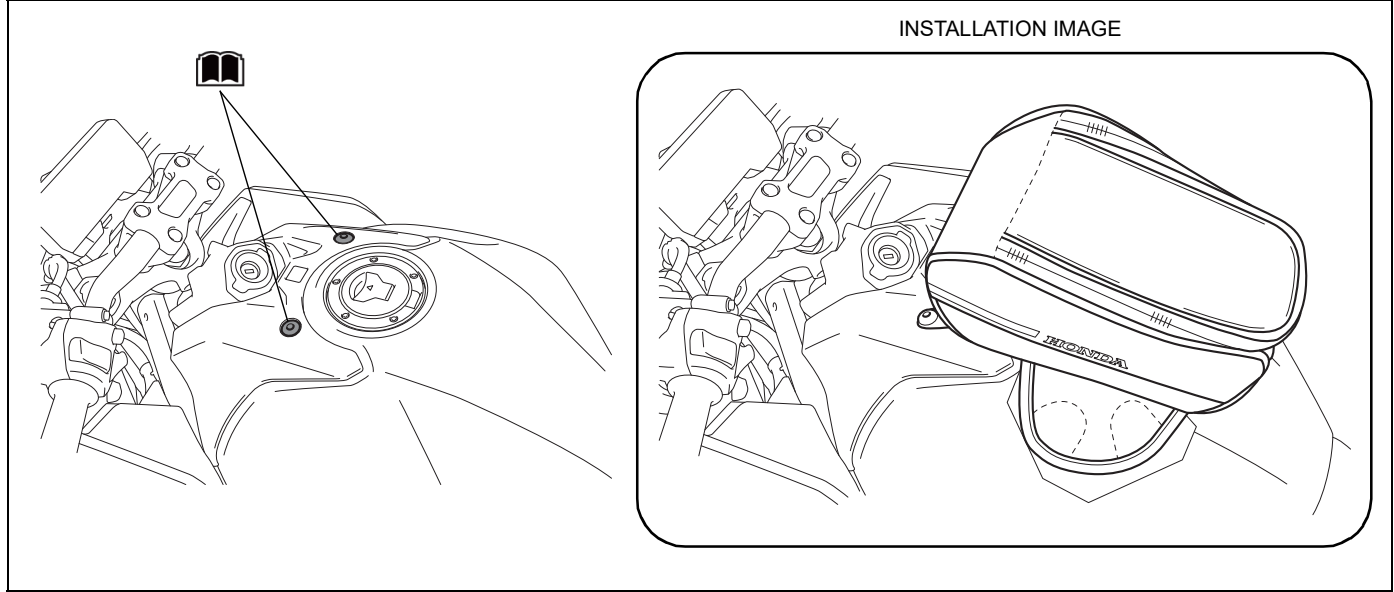

2. Cut to the dimensions shown.

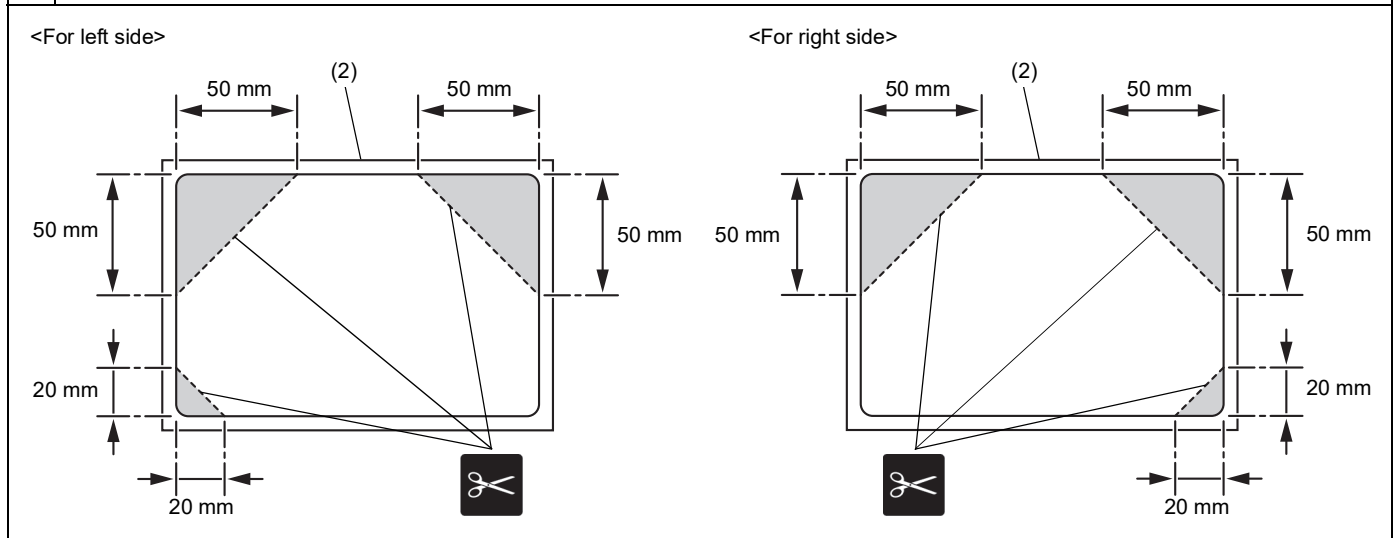

3. Install as shown.

<For left side>

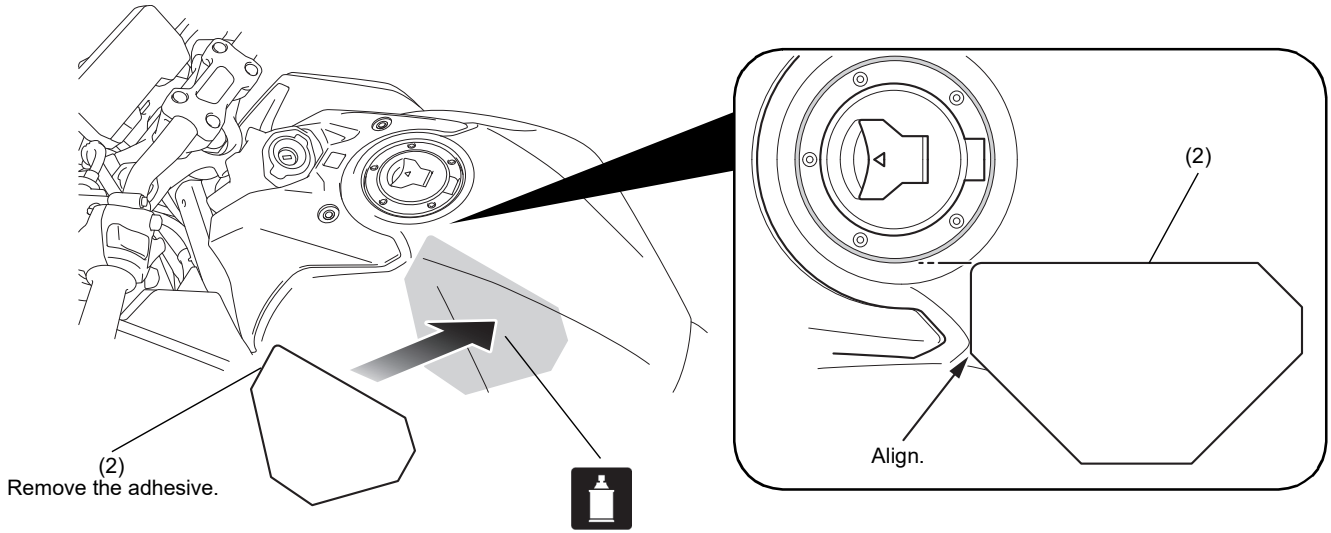

4. Install the right side in the same manner as the left side.

5. Install as shown.

